

APC Laser Diode™

Perfect Solution For Auto Power Controlled Laser Diode

ADL-63153TB4

T6-2D-LD63-008_Rev.01

By converting the external APC circuit board into an ASIC, we package the APC circuit into a traditional TO-can together with the laser chip. From now on, single package APC function included laser diode is realized.

Powered with Arima's proprietary **APC Laser Diode™** technology, **ADL-63153TB4** is your perfect solution for the stable light power output, compact size, high brightness laser light source.

Features:

1. 635nm 15mW 50°C high reliable operation
2. Saving space and cost of laser module
3. Voltage driven LD, easy to use
4. Highly stable laser output power



Applications:

1. High precision measuring instruments
2. High precision industrial makers
3. Survey and engineering instruments

ADL-63153TB4 Electrical-Optical Characteristics @T_c=25°C:

Item	Symbol	Min.	Typ.	Max	Unit	Condition
Wavelength	λ	630	639	645	nm	P _o =15mW
Operation current	I _{op}	-	66	100	mA	P _o =15mW
Variable resistor	VR	6	15	22	K Ω	V _{cc} =3V
Parallel divergence angle	$\theta_{//}$	5	8	12	Deg	P _o =15mW
Perpendicular divergence angle	θ_{\perp}	25	33	40	Deg	
Parallel FFP deviation angle	$\Delta\theta_{//}$	-3.0	0	+3.0	Deg	
Perpendicular FFP deviation angle	$\Delta\theta_{\perp}$	-3.0	0	+3.0	Deg	
Emission point accuracy	$\Delta x\Delta y\Delta z$	-80	0	+80	um	-
Power-Temp stability (25~50°C)	ΔP_{oT}	-20	-10	0	%	Po=15mW,Vcc=3.0V
Power-V _{cc} stability (6.0~3.0V)	ΔP_{oV}	-15	-10	0	%	Po=15mW,Temp=25°C
Power-V _{cc} stability (3.0~2.5V)	ΔP_{oV}	-15	-10	0	%	Po=15mW,Temp=25°C

Maximum Ratings:

Item	Symbol	Rating	Unit
Power supply voltage	V _{cc}	2.5~6.0	V
Laser optical output power	P _o	18.0	mW
Operation temperature	T _{opr}	-10 ~ +50	°C
Storage temperature	T _{stg}	-40 ~ +85	°C
Reverse Current	I _{RD}	0~600	mA

* Effective heat sink is recommended on 6V case due to extra heat.

Block Diagram:

1. Traditional LD needs to connect an external APC circuit board for the constant power operation. The VR (variable resistor) is used to adjust the laser output to a desired target power.
2. **ADL-63153TB4** consists an APC IC inside the **TO-5.6mm** package, and leaves the VR outside for adjusting the optical output power.
3. Oscillation Damper is recommended for stabilizing the optical output power.
4. Battery reverse protection is recommended for protecting the APC Circuit.

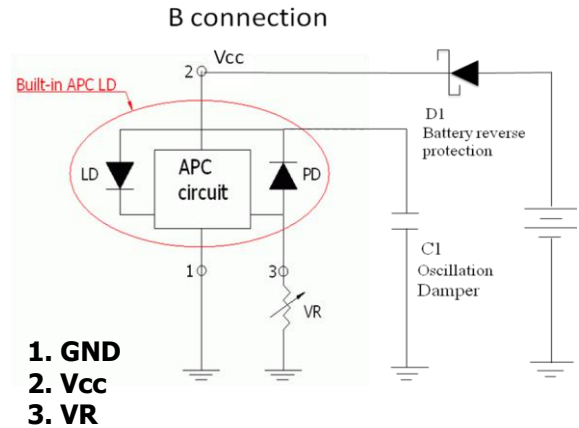

Outline Dimension & Pin Assignment:

1. GND
2. V_{CC}
3. VR

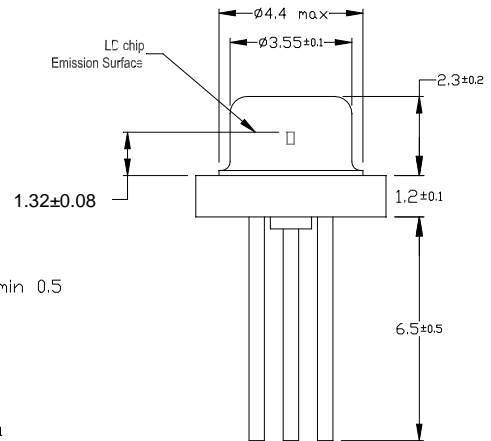
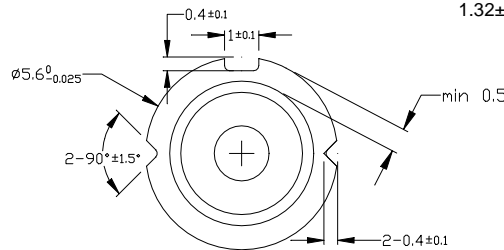
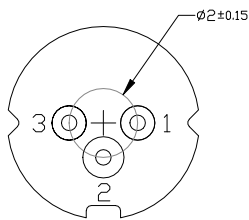

Laser Safety Precautions

1. To protect laser from overdriving condition, setting VR to maximum value before you turn on Vcc can minimized the laser output power.
2. Do not operate the device above the maximum rating condition, even momentarily. It may cause unexpected permanent damage to the device.
3. Semiconductor laser device is very sensitive to electrostatic discharge. High voltage spike current may change the characteristics of the device, or malfunction at any time during its service period. Therefore, proper measures for preventing electrostatic discharge are strongly recommended.
4. To obtain a stable characteristic and good reliability, the effective heat sink is necessary. So it is recommended that always apply proper heat sink before the device is operating.-
5. Do not look into the laser beam directly by bare eyes. The laser beam may cause severe damage to human eyes.